



PRESVLAKA	PRESVLAKA	Mebl-štof; Eko koža (PU);
	ŠAVOVI	U boji presvlake (TT)
	KEDERI	U boji presvlake
	FIKSNA ILI UKLONIVA	Fiksna
PUNILO	JAS. SEDIŠTA	Poliuretanska pena gustine N 35 kg/m ³ + sloj akrilnih vlakana gustine 200 gr/m ²
	JAS. NASLONA	Silikonsko vlakno
	UKR. JASTUCI	-
	KORPUS/RUKON.	Poliuretanska pena gustine 20 kg/m ³
GEŠTELA	RAM	Čamova, bukova građa, iverica, oplemenjena iverica, lesomit, siva lepenka
	KONSTRUKCIJA	Lepak i klamarice
	SEDIŠTE OSLANJANJE	Elastična gurtina
	NASLON OSLANJANJE	-
MEHANIZAM & DUŠEK	TIP	Makaze na izvlačenje – lift mehanizam
	DUŠEK	Poliuretanska pena gustine 23 kg/m ³
NOGICE	MONTAŽA	Montirane
	GLAVNA NOG. MAT.	Drvena
	BOJA	Crna ili po želji kupca od raspoloživih nijansi

RASPOLOŽIVE VERZIJE

ŠIFRA	ELEMENTI FIKSNI	ŠIFRA	ELEMENTI UGAONA GARNITURA	ŠIFRA	OSTALI ELEMENTI
030M	TROSED MEHANIZAM	025	2,5-SED LEVI	031	TROSED LEVI
030	TROSED FIKSNI	025M	2,5-SED LEVI MEHANIZAM	031M	TROSED LEVI MEHANIZAM
020	DVOSED	026	2,5-SED DESNI	032	TROSED DESNI
010	FOTELJA	026M	2,5-SED DESNI MEHANIZAM	032M	TROSED DESNI MEHANIZAM
006	TABURE MAXI	041	PRODUŽENA FOTELJA LEVA	033	TROSED TERMINAL
005	TABURE	042	PRODUŽENA FOTELJA DESNA	033M	TROSED TERMINAL MEHANIZAM

*Navedene dimenzije u realnosti mogu odstupati u rasponu ±2-3%. Zadržavamo pravo izmene na modelima u cilju poboljšanja njihovih karakteristika.

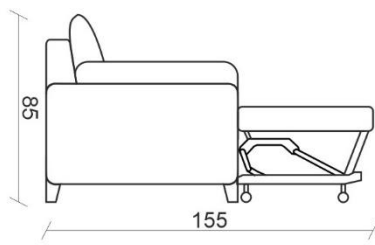
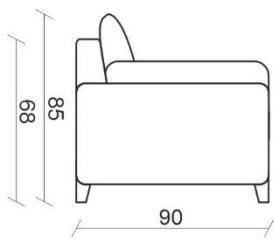

TROSED FIKSNI

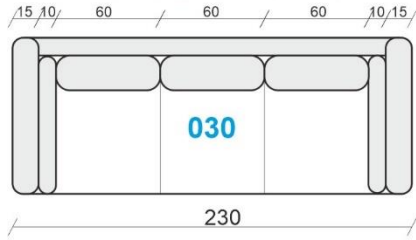

DVOSED FIKSNI

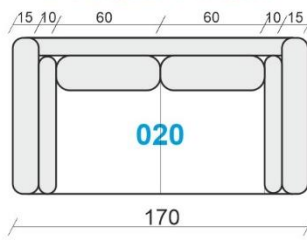

FOTELJA

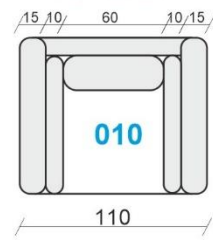

TROSED LEVI FIKSNI

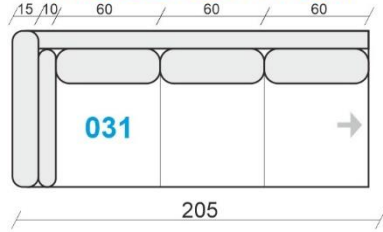

TROSED DESNI FIKSNI

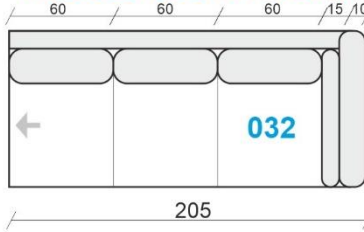

TROSED TERMINAL FIKSNI

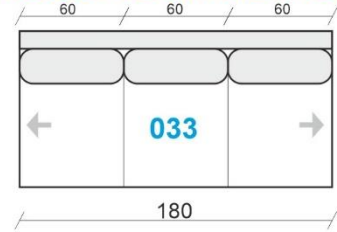

TROSED LEVI MEH.

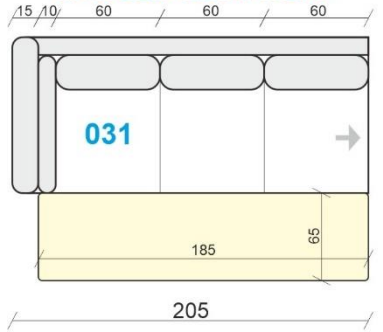

TROSED DESNI MEH.

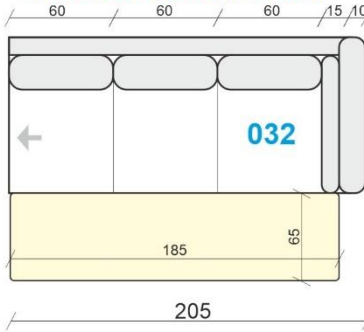

TROSED TERMINAL MEH.

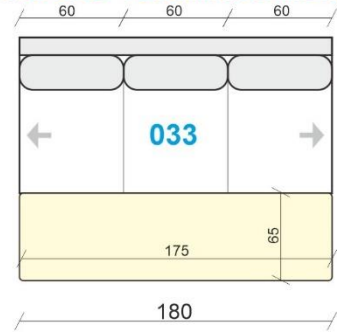

TROSED MEHANIZAM

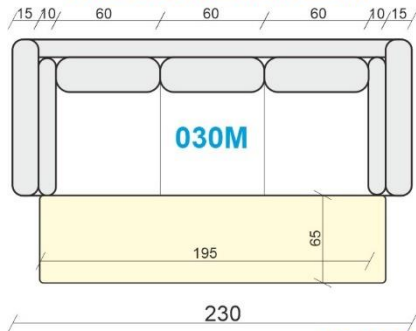

2,5-SED LEVI MEH.

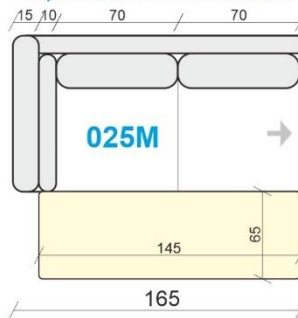

2,5-SED DESNI MEH.

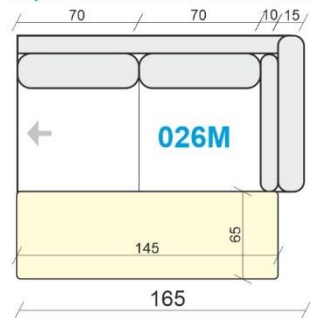

2,5-SED LEVI

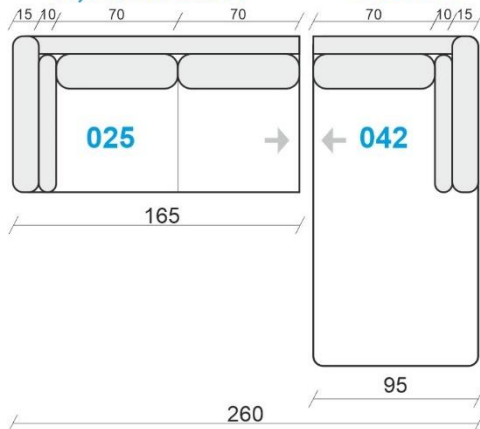

PROD. FOT. DESNA

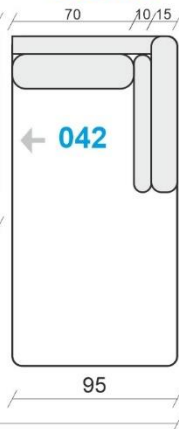

PROD. FOT. LEVA

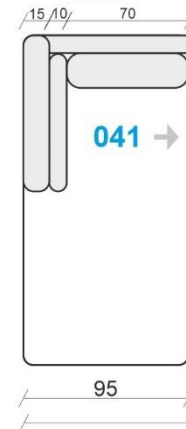

2,5-SED DESNI

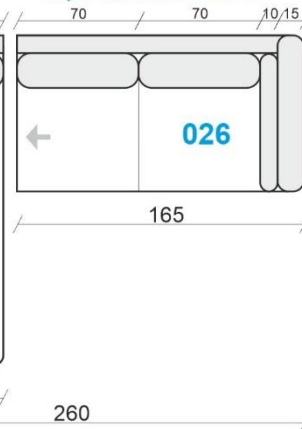

TABURE MAXI



TABURE

